



# Scotsman® CM450SL

Vertical  
Contour  
Ice Production



- CME1656
- CME1356
- CME1056
- CME 656
- CME 506
- CME 456
- CM450SL**
- SCE 275

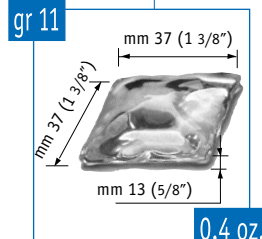
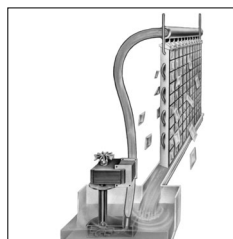

**CONTOUR ICE**

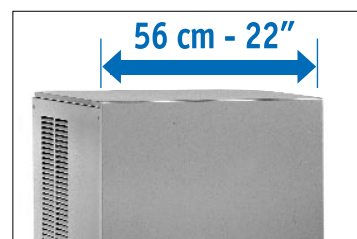
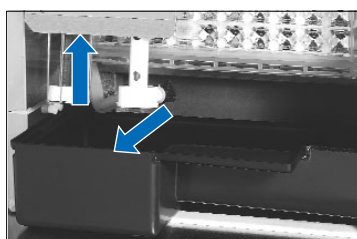
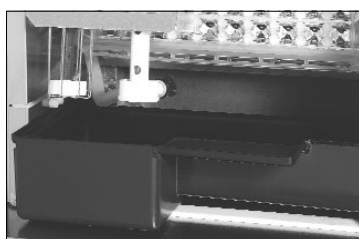
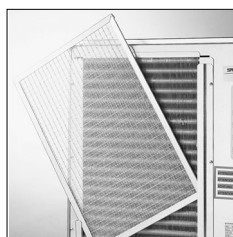

**Modular  
Contour  
Cube Ice  
Machine**

**Machine  
Modulaire  
à Glaçon  
Contour**

**Contour  
Kombi  
Eisbereiter**

**Máquina  
Modulare  
Fabricadora  
de Cubitos  
Contour**

**Fabbricatore  
Modulare  
di Ghiaccio  
Contour**

	[kg]	[lbs]	N° <sup>□</sup> *	[kg]	[lbs]	N° <sup>□</sup> *	[v/Hz/ph]	[HxWxD mm]	[HxWxD inches]	
CM 450 SL AS	210	463	19000	100	220	8700	230/50/1	696x560x600	27 3/8" x 22" x 23 1/2"	R 404 A
CM 450 SL WS	200	440	18100	100	220	8700	230/50/1	696x560x600	27 3/8" x 22" x 23 1/2"	R 404 A

\*Estimate

**Accessories** CM 450 SL (included):

- Water inlet hose
- Water drain hose
- Metal air deflector

**Options** (order separately):

Caster Kit for B 193  
(code no. KRB 550)

## 2

Years Warranty  
Ans de Garantie  
Jahre Garantie  
Años de Garantía  
Anni di Garanzia

Subject to certain limitations and exclusions  
Assujettie aux limites et exclusions prescrites  
Abhängig von Bestimmten Einschränkungen und Ausnahmen  
Sujeta a ciertas limitaciones y exclusiones.  
Soggetta ad alcune limitazioni ed esclusioni



This product qualifies for the following listings:



Models and specifications are subject to change without notice - Les modeles et les caracteristiques des appareils peuvent être changés sans préavis - Wir behalten das Recht vor jederzeit Änderungen der Modelle und der technischen Angaben vorzunehmen. Los modelos y las características pueden ser modificados en cualquier momento sin previo aviso - I modelli e le specifiche possono essere cambiate in qualunque momento senza preavviso

ADV-CM450SL - 5/2003

# CM450SL

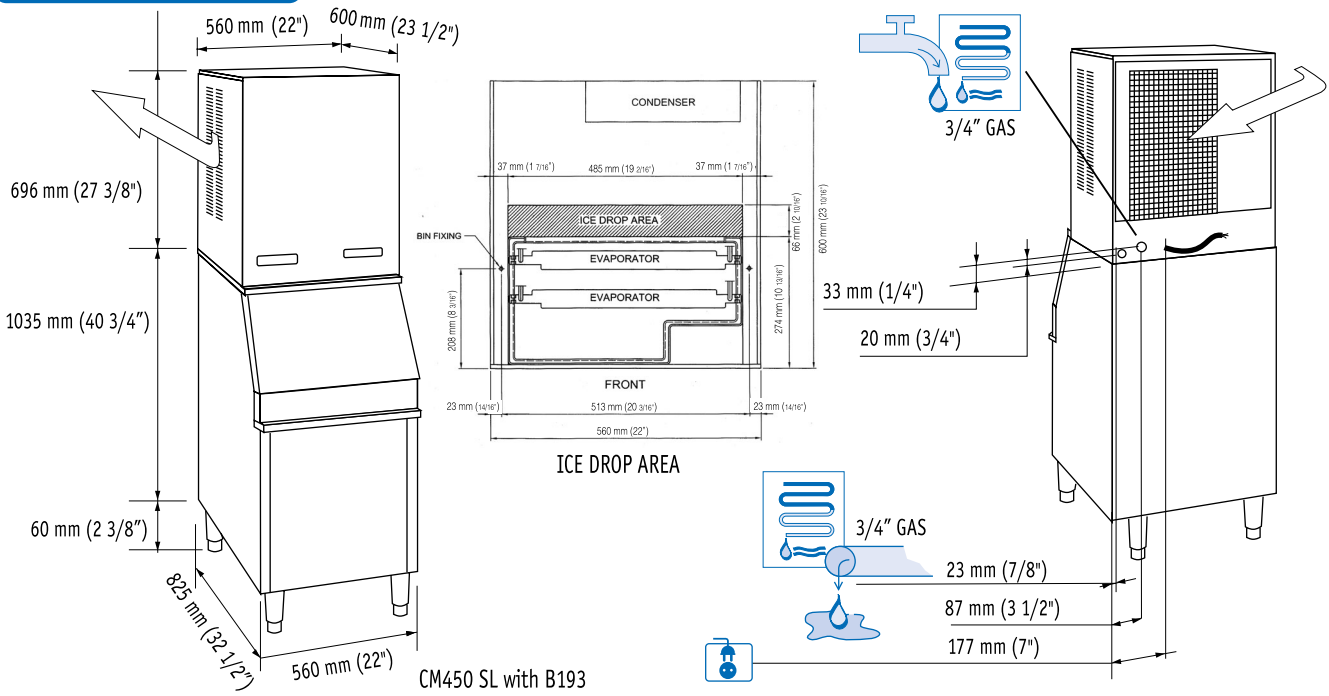

CM450 SL with B193

	+C° -C°	[Btu/h] [W]	[Ømm <sup>2</sup> ]	[W]	FUSE	[kWh] 24h	[L/h] [gal/h]	32°C 90°F 21°C 70°F	[kg] [lbs]	[kg] [lbs]	[kg] [lbs]	[kg] [lbs]
CM 450 SL AS		10750 3150	3 x 1,5	1250 W	16 A	30	16 4.3		84 185	97 214		
CM 450 SL WS		10750 3150	3 x 1,5	1000 W	16 A	24	136 37		84 185	97 214		

## CM 450 SL AIR

°F	50°	60°	70°	90°	
°C	10°	15°	21°	32°	
10°	210	205	195	180	kg
50°	463	452	430	397	lbs
21°	195	190	180	170	kg
70°	430	419	397	375	lbs
32°	175	170	165	155	kg
90°	386	375	364	342	lbs
38°	150	145	140	130	kg
100	331	320	309	287	lbs



## CM 450 SL WATER

°F	50°	60°	70°	90°	
°C	10°	15°	21°	32°	
10°	200	195	185	170	kg
50°	440	429	407	374	lbs
21°	195	190	180	165	kg
70°	429	418	396	363	lbs
32°	182	178	170	155	kg
90°	400	392	374	341	lbs
38°	175	172	165	148	kg
100	385	378	363	325	lbs



Minimum		Maximum
10°C (50°F)		40°C (104°F)
5°C (41°F)		35°C (95°F)
-10%		+10%
1 BAR 14 psi		5 BAR 70 psi

Machine requires voltage indicated on rating name plate. Failures caused by improper voltage are not considered factory defects. Scotsman products are not designed for outdoor installation. Extended periods of operation at temperatures exceeding the above limitations constitutes misuse under the terms of Scotsman Limited Warranty, resulting in a loss.

La machine doit être raccordée conformément au voltage indiqué sur la plaque signalétique. Les éventuels dégâts causés par un non respect de cette consigne ne peuvent être considérés comme des défauts de fabrication. Les machines à glace Scotsman ne sont pas conçues pour être utilisées à l'extérieur. Le fonctionnement prolongé à des températures supérieures ou inférieures aux limites ci-dessus sont considérées comme une mauvaise utilisation dans le cadre de la garantie Scotsman.

Der Eisbereiter benötigt eine Stromspannung gemäß Geräte-Typenschild. Störungen oder Ausfälle, durch den Betrieb mit falscher Stromspannung sind keine Fabrikationsfehler und fallen nicht unter Garantie. Scotsman Eisbereiter sind nicht für die Installation im Freien geeignet. Der längere Betrieb bei Temperaturen über den obigen Grenzwerten ist eine falsche Anwendung und bedeutet den Verlust der Garantieleistung.

Los requerimientos eléctricos de la máquina están indicados en la placa de características. Los daños causados por voltajes inadecuados no son considerados defectos de fábrica. La máquina de hielo Scotsman, no están diseñadas para trabajar a la intemperie. Largos periodos de funcionamiento a temperaturas que excedan de las limitaciones indicadas, constituyen maltrato de acuerdo con las observaciones de Scotsman.

La macchina richiede il voltaggio indicato sulla targhetta di identificazione. Danni causati da voltaggi diversi non sono considerati difetti di produzione. I prodotti Scotsman non vanno utilizzati all'aperto. Un prolungato periodo di utilizzo al di fuori delle temperature indicate non è consentito e causa l'automatico decadere della garanzia.

**Scotsman**® The one the world relies on.™  
Ice Systems



**USA, Canada, Latin America**  
Scotsman Ice Systems USA  
775 Corporate Woods Parkway  
Vernon Hills, IL 60061  
Ph: (847) 215-4550  
Fax: (847) 913-9844  
customer.service@scotsman-ice.com

**Europe**  
Scotsman Europe-Frimont S.p.A.  
Via Puccini, 22  
20010 Pogliano (Milano) Italy  
Ph: (+39) 02-93960208  
Fax: (+39) 02-93960201  
scotsman.europe@frimont.it

**Asia and Pacific**  
Scotsman Ice Systems-Frimont S.p.A. (R.O.)  
627A Aljunied Road-#04-04 Biztech Centre  
Singapore 389842  
Ph: (+65) 6738 5393  
Fax: (+65) 6738 1959  
scotsice@singnet.com.sg

**China**  
Scotsman Ice Systems  
258 Tong Ren Road Golden Tower 7A  
Shanghai-200040 People's Republic of China  
Ph: (+86) 21-62476056  
Fax: (+86) 21-62476126  
scotsmansh@online.sh.cn

**Middle East & N. Africa**  
Scotsman Ice Systems Dubai Office  
P.o. Box 13205 - Deira  
Dubai - U.A.E.  
Ph: +9716-5654036  
Fax: +9716-5654063  
scotsman@emirates.net.ae

**South Africa**  
Scotsman Ice Systems S.A.Pty. Ltd.  
69, Audley Road - 2021 Bryanston  
P.o. Box 44-2149 Riverclub-S. Africa  
Ph: +27-11-4636244/5  
Fax: +27-11-4631411  
scotsman@telkomsa.net