

Ice Dispenser: storage capacity up to 59 Kg



Features

- Stores up to 59 Kg (120 lbs.) of cube ice.
- Simple push chute for easy ice dispensing.
- Modern, stylish design in a stainless steel cabinet.
- Removeable top panel allows access to the bin for easy cleaning without having to remove the ice machine.
- Improved sink depth that will accommodate almost every size hotel ice bucket.
- Equipped with an 11 ft. power cord.
- Match the iceValet® dispenser with a Scotsman Prodigy® ice machine featuring self-monitoring technology, cost-saving energy efficiency, extended time between cleanings, easy-access servicing and built-in anti-microbial protection. All these features add up to the smartest choice in ice.

Polyurethane Insulation

Foam insulation is forced between the wall and liner under heat and pressure to form a perfect wall to wall bond, preserving ice supply for long periods.



Easy Push Shute

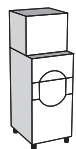

HD22+MV306
(sold separately)

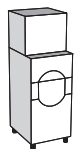

HD22+MV426
(sold separately)

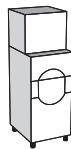

HD22+C322
(sold separately)

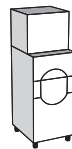

HD22+C522
(sold separately)

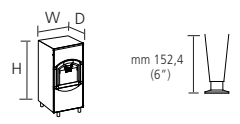
	 DICE CUBE			 mm 152,4 (6")
	[kg]	[lbs]	N°*	[WxDxH mm]
HD 22	59	120	5900	558x850x1351
				[WxDxH inches] 22"x33 1/2"x53 1/4"

*Estimated number of Dice Cubes

This product qualifies for the following listings:



Medium Cube - 10 g
W 23 x D 23 x H 26 mm



Small Cube - 6 g
W 11 x D 23 x H 26 mm

2 Years Warranty

Subject to certain limitations and exclusions

Certified ISO 9001:2000

www.scotsman-ice.it
www.scotsman-ice.com
www.scotsman-ice-on-tablet.com

Models and specifications are subject to change without notice.

Ice Dispenser: storage capacity up to 59 Kg

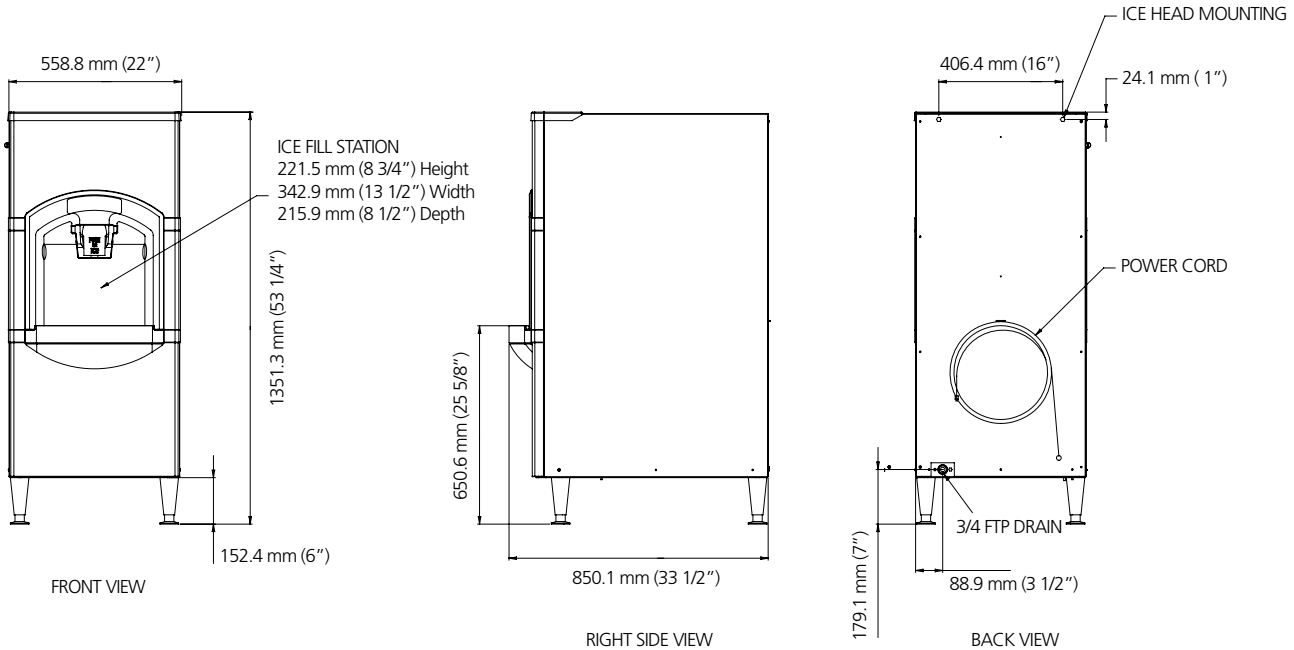

Minimum		Maximum
10°C (50°F)		40°C (104°F)
5°C (41°F)		35°C (95°F)
-10%		+10%
1 BAR 14 psi		5 BAR 70 psi

	 [Ømm²]	 FUZE	 [kg] [lbs]	 [lbs]
HD 22	-	15 A	84 185	199