

Scotsman® MDT5N25

- TC 180
- MDT3F12
- MDT4F12
- MDT5N25**
- MDT5N40
- NME 654
- CD 40
- HD 30
- HD 22

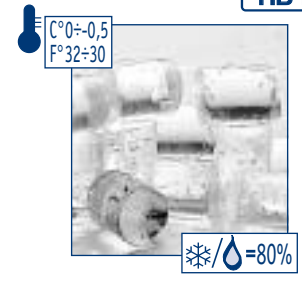

NUGGET ICE

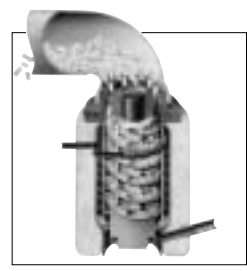

MDT5N25 with MDS21 Stand











Nugget Ice and Water Dispenser

Distributeur d'Eau et de Glace Nugget

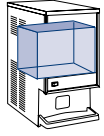
Wasser und Nuggeteis Dispenser

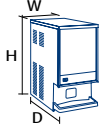
Dispensador de Hielo Nugget y Agua

Distributore di Ghiaccio Nugget e Acqua

	 +C° -C°	 24h NUGGET ICE				
		[kg] [lbs]	[kg] [lbs]	[v/Hz/ph]	[WxDxH mm] [WxDxH inches]	
MDT5N25 A		237 523	12 26	230/50/1	660x571x1104 26x22,5x41"	R 404 a
MDT5N25 W		238 525	12 26	230/50/1	660x571x1104 26x22,5x41"	R 404 a

Accessory:
• DMS21 Stainless steel Stand

2

Years Warranty
Ans de Garantie
Jahre Garantie
Años de Garantía
Anni di Garanzia

Subject to certain limitations and exclusions
Assujettie aux limites et exclusions prescrites
Abhängig von Bestimmten Einschränkungen und Ausnahmen
Sujeta a ciertas limitaciones y exclusiones.
Soggetta ad alcune limitazioni ed esclusioni



This product qualifies for the following listings:

Models and specifications are subject to change without notice - Les modeles et les caracteristiques des appareils peuvent être changés sans préavis - Wir behalten das Recht vor jederzeit Änderungen der Modelle und der technischen Angaben vorzunehmen. Los modelos y las características pueden ser modificados en cualquier momento sin previo aviso - I modelli e le specifiche possono essere cambiate in qualunque momento senza preavviso

MDT5N25

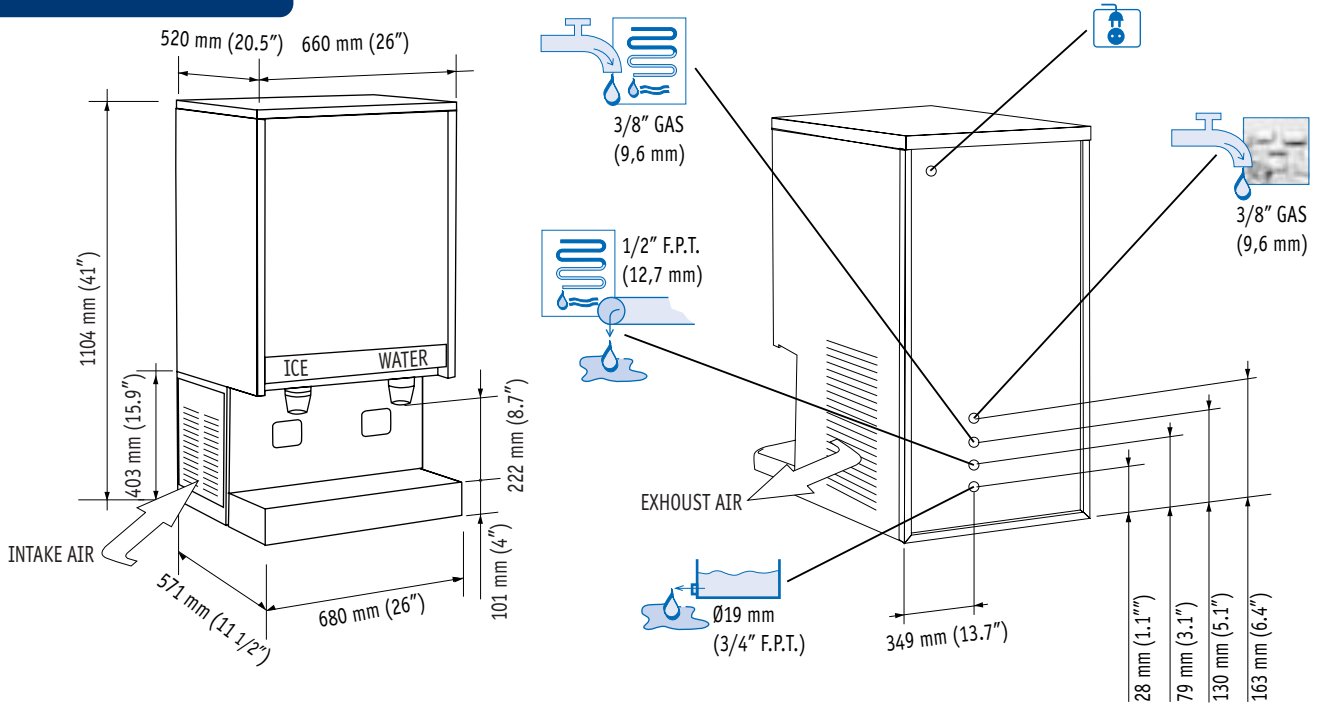

	+C° -C°	[Btu/h] [W]	[Ømm ²]	[W]	FUSE	[kWh]	24h	[l/h] [gal/h]	32°C 90°F 21°C 70°F	[kg] [lbs]	[kg] [lbs]	[kg] [lbs]	
MDT5N25 A		4300 1260	3 x 1.5	1.100	15	22		8 2		104 230	118 260		
MDT5N25 W		4300 1260	3 x 1.5	1.100	15	8		70 18		104 230	118 260		

MDT5N25 AIR COOLED

°C \ °F	50° 10°	60° 15°	70° 21°	90° 32°	
10°	—	—	—	—	kg
50°	—	—	—	—	lbs
21°	220	—	—	—	kg
70°	482	—	—	—	lbs
32°	—	—	168	—	kg
90°	—	—	370	—	lbs
38°	—	—	—	—	kg
100°	—	—	—	—	lbs

MDT5N25 WATER COOLED

°C \ °F	50° 10°	60° 15°	70° 21°	90° 32°	
10°	—	—	—	—	kg
50°	—	—	—	—	lbs
21°	215	—	—	—	kg
70°	473	—	—	—	lbs
32°	—	—	186	—	kg
90°	—	—	410	—	lbs
38°	—	—	—	—	kg
100°	—	—	—	—	lbs

Minimum

10°C (50°F)
5°C (41°F)
-10%
1 BAR 14 psi



Maximum

40°C (104°F)
35°C (95°F)
+10%
5 BAR 70 psi

Machine requires voltage indicated on rating name plate. Failures caused by improper voltage are not considered factory defects. Scotsman products are not designed for outdoor installation. Extended periods of operation at temperatures exceeding the above limitations constitutes misuse under the terms of Scotsman Limited Warranty, resulting in a loss.

La machine doit être raccordée conformément au voltage indiqué sur la plaque signalétique. Les éventuels dégâts causés par un non respect de cette consigne ne peuvent être considérés comme des défauts de fabrication. Les machines à glace Scotsman ne sont pas conçues pour être utilisées à l'extérieur. Le fonctionnement prolongé à des températures supérieures ou inférieures aux limites ci-dessus sont considérées comme une mauvaise utilisation dans le cadre de la garantie Scotsman.

Der Eisbereiter benötigt eine Stromspannung gemäß Geräte-Typenschild. Störungen oder Ausfälle, durch den Betrieb mit falscher Stromspannung sind keine Fabrikationsfehler und fallen nicht unter Garantie. Scotsman Eisbereiter sind nicht für die Installation im Freien geeignet. Der längere Betrieb bei Temperaturen über den obigen Grenzwerten ist eine falsche Anwendung und bedeutet den Verlust der Garantieleistung.

Los requerimientos eléctricos de la máquina están indicados en la placa de características. Los daños causados por voltajes inadecuados no son considerados defectos de fábrica. La máquinas de hielo Scotsman, no están diseñadas para trabajar a la intemperie. Largos periodos de funcionamiento a temperaturas que excedan de las limitaciones indicadas, constituyen maltrato de acuerdo con las observaciones de Scotsman.

La macchina richiede il voltaggio indicato sulla targhetta di identificazione. Danni causati da voltaggi diversi non sono considerati difetti di produzione. I prodotti Scotsman non vanno utilizzati all'aperto. Un prolungato periodo di utilizzo al di fuori delle temperature indicate non è consentito e causa l'automatico decadere della garanzia.



Scotsman® The one the world relies on.
Ice Systems

Certified ISO 9001:2000

USA, Canada, Latin America
Scotsman Ice Systems USA
775 Corporate Woods Parkway
Vernon Hills, IL 60061
Ph: (+1) 847 215-4550
Fax (+1) 847 913-9844
customer.service@scotsman-ice.com

Europe
Scotsman Europe-Frimont S.p.A.
Via Puccini, 22
20010 Pogliano (Milano) Italy
Ph: (+39) 02-93960208
Fax: (+39) 02-93960201
scotsman.europe@frimont.it

Asia and Pacific
Scotsman Ice Systems-Frimont S.p.A. (R.O.)
627A Aljunied Road-#04-04 Biztech Centre
Singapore 389842
Ph: (+65) 6738 5393
Fax: (+65) 6738 1959
scotsice@singnet.com.sg

China
Scotsman Ice Systems (Shanghai) Co. Ltd
613 Kaisuan Road, Building G
Shanghai, China 200051
Ph: (+86) 2161526100
Fax: (+86) 2161526020
sales@enodis.com.cn - service@enodis.com.cn

Middle East & N. Africa
Scotsman Ice Systems Dubai Office
P.o. Box 21648
Sharjah - U.A.E.
Mobile: Ph: (+971) 505505980
Fax (+971) 6-5654063
scotsman@eim.ae

South Africa
Scotsman Ice Systems SA (PTY) Ltd.
10, Rhodes Street - Kensington B
P.o. Box 44 - Riverclub 2149
Ph: (+27) 11-7898400
Fax (+27) 11-7898411
scotsman@telkomsa.net